

Dynamics and thermalization in isolated quantum systems

Marcos Rigol

Department of Physics
The Pennsylvania State University

QCD Hadronization and the Statistical Model

ECT* Trento, Italy

October 6, 2014

With comments
by H.G. Evertz
v2021

- 1 Introduction
 - Experiments with ultracold gases
 - Unitary evolution and thermalization

- 2 Generic (nonintegrable) systems
 - Time evolution vs exact time average
 - Statistical description after relaxation
 - Eigenstate thermalization hypothesis
 - Time fluctuations

- 3 Integrable systems
 - Time evolution
 - Generalized Gibbs ensemble

- 4 Summary

Experiments with ultracold gases in 1D

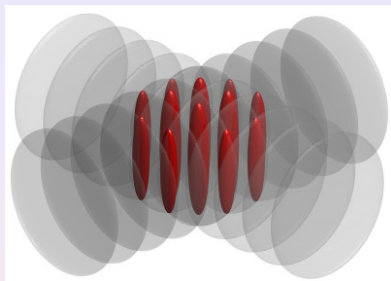

Effective one-dimensional δ potential

M. Olshanii, PRL **81**, 938 (1998).

$$U_{1D}(x) = g_{1D}\delta(x)$$

where

$$g_{1D} = \frac{2\hbar a_s \omega_{\perp}}{1 - C a_s \sqrt{\frac{m\omega_{\perp}}{2\hbar}}}$$

Experiments with ultracold gases in 1D

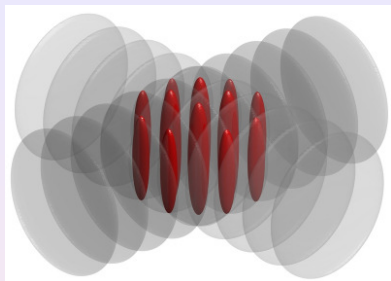

Effective one-dimensional δ potential

M. Olshanii, PRL **81**, 938 (1998).

$$U_{1D}(x) = g_{1D}\delta(x)$$

where

$$g_{1D} = \frac{2\hbar a_s \omega_{\perp}}{1 - C a_s \sqrt{\frac{m\omega_{\perp}}{2\hbar}}}$$

Girardeau '60, Lieb and Liniger '63

T. Kinoshita, T. Wenger, and D. S. Weiss,
Science **305**, 1125 (2004).

T. Kinoshita, T. Wenger, and D. S. Weiss,
Phys. Rev. Lett. **95**, 190406 (2005).

$$\gamma_{\text{eff}} = \frac{m g_{1D}}{\hbar^2 \rho}$$

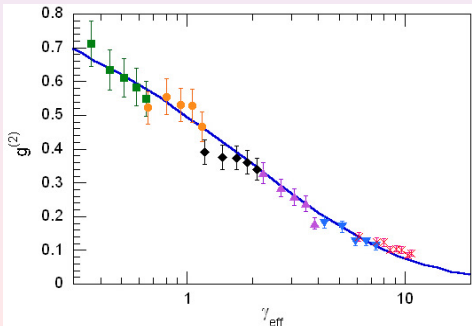

Absence of thermalization in 1D?

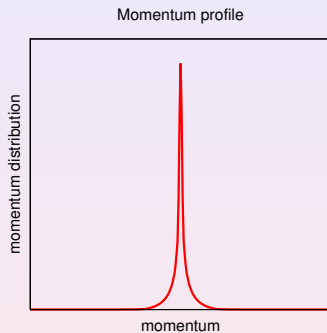
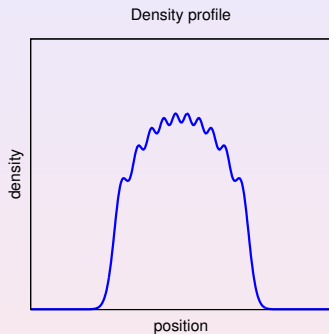

T. Kinoshita, T. Wenger, and D. S. Weiss, *Nature* **440**, 900 (2006).

MR, A. Muramatsu, and M. Olshanii, *Phys. Rev. A* **74**, 053616 (2006).

Absence of thermalization in 1D?

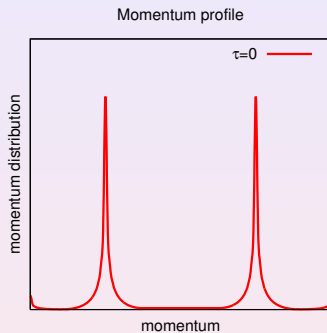
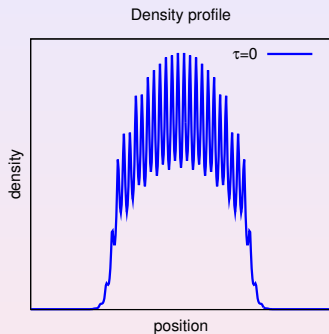

T. Kinoshita, T. Wenger, and D. S. Weiss, *Nature* **440**, 900 (2006).

MR, A. Muramatsu, and M. Olshanii, *Phys. Rev. A* **74**, 053616 (2006).

Absence of thermalization in 1D?

In this experiment:
periodic movement,
no thermalization

Experiment

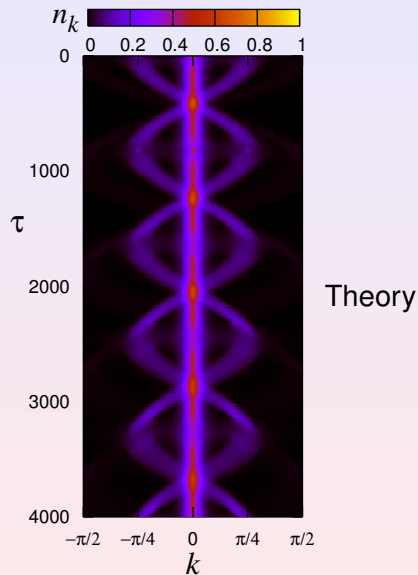
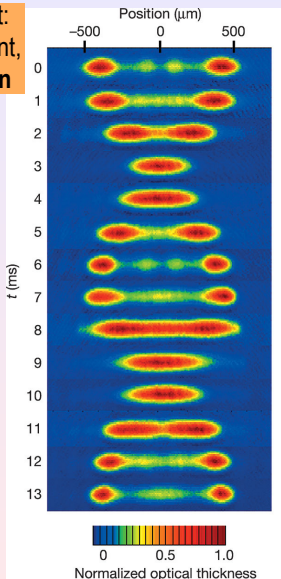

Absence of thermalization in 1D?

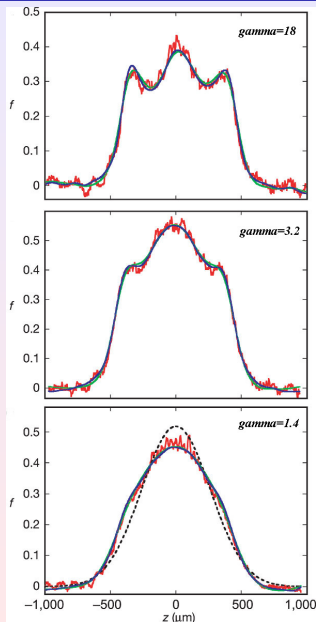

T. Kinoshita, T. Wenger, and D. S. Weiss,
Nature **440**, 900 (2006).

$$\gamma = \frac{mg_{1D}}{\hbar^2 \rho}$$

g_{1D} : Interaction strength
 ρ : One-dimensional density

If $\gamma \gg 1$ the system is in the
strongly correlated
Tonks-Girardeau regime

If $\gamma \ll 1$ the system is in the
weakly interacting regime

Gring *et al.*, *Science* **337**, 1318 (2012).

1 Introduction

- Experiments with ultracold gases
- Unitary evolution and thermalization

2 Generic (nonintegrable) systems

- Time evolution vs exact time average
- Statistical description after relaxation
- Eigenstate thermalization hypothesis
- Time fluctuations

3 Integrable systems

- Time evolution
- Generalized Gibbs ensemble

4 Summary

Classical physics:

Chaotic evolution --> ergodicity (uniform)
--> thermal description

(Exception: integrable systems:
many conserved quantities
--> orbits in phase space,
not ergodic)

Quantum physics:

NOT ergodic ! (only a tiny part of Hilbert
space is relevant)

Is there thermalization of an isolated system?
In what sense ?

Need to consider states, observables,
matrix elements

(Integrable systems again do not thermalize)

Exact results from quantum mechanics

If the initial state is not an eigenstate of \hat{H}

$$|\psi_0\rangle \neq |\alpha\rangle \quad \text{where} \quad \hat{H}|\alpha\rangle = E_\alpha|\alpha\rangle \quad \text{and} \quad E_0 = \langle\psi_0|\hat{H}|\psi_0\rangle,$$

then a generic observable O will evolve in time following

$$O(\tau) \equiv \langle\psi(\tau)|\hat{O}|\psi(\tau)\rangle \quad \text{where} \quad |\psi(\tau)\rangle = e^{-i\hat{H}\tau}|\psi_0\rangle.$$

Exact results from quantum mechanics

If the initial state is not an eigenstate of \hat{H}

$$|\psi_0\rangle \neq |\alpha\rangle \quad \text{where} \quad \hat{H}|\alpha\rangle = E_\alpha|\alpha\rangle \quad \text{and} \quad E_0 = \langle\psi_0|\hat{H}|\psi_0\rangle,$$

then a generic observable O will evolve in time following

$$O(\tau) \equiv \langle\psi(\tau)|\hat{O}|\psi(\tau)\rangle \quad \text{where} \quad |\psi(\tau)\rangle = e^{-i\hat{H}\tau}|\psi_0\rangle.$$

What is it that we call thermalization?

Thermal expectation value expected to depend only on a few parameters !

average: $\overline{O(\tau)} \stackrel{?}{=} O(E_0) \stackrel{?}{=} O(T) \stackrel{?}{=} O(T, \mu).$

(Definitions follow) "diagonal ensemble" =? microcan. =? canonical =? grand canonical ensemble (in therm.dyn. limit)

Exact results from quantum mechanics

If the initial state is not an eigenstate of \hat{H}

$$|\psi_0\rangle \neq |\alpha\rangle \quad \text{where} \quad \hat{H}|\alpha\rangle = E_\alpha|\alpha\rangle \quad \text{and} \quad E_0 = \langle\psi_0|\hat{H}|\psi_0\rangle,$$

then a generic observable O will evolve in time following

$$O(\tau) \equiv \langle\psi(\tau)|\hat{O}|\psi(\tau)\rangle \quad \text{where} \quad |\psi(\tau)\rangle = e^{-i\hat{H}\tau}|\psi_0\rangle.$$

What is it that we call thermalization?

$$\overline{O(\tau)} = O(E_0) = O(T) = O(T, \mu).$$

"diagonal ensemble" =? microcan. =? canonical =? grand canonical ensemble (in therm.dyn. limit)

One can rewrite

$$O(\tau) = \sum_{\alpha', \alpha} C_{\alpha'}^* C_\alpha e^{i(E_{\alpha'} - E_\alpha)\tau} O_{\alpha'\alpha} \quad \text{where} \quad |\psi_0\rangle = \sum_{\alpha} C_\alpha |\alpha\rangle,$$

(Assume: no degeneracies)

and taking the infinite time average (diagonal ensemble) (=definition(!) of "diag. ensemble")
(could also integrate from some later time)

$$\overline{O(\tau)} = \lim_{\tau \rightarrow \infty} \frac{1}{\tau} \int_0^\tau d\tau' \langle\Psi(\tau')|\hat{O}|\Psi(\tau')\rangle = \sum_{\alpha} |C_\alpha|^2 O_{\alpha\alpha} \equiv \langle\hat{O}\rangle_{\text{diag}}$$

(since all oscillating terms vanish after integral)

which depends on the initial conditions through $C_\alpha = \langle\alpha|\psi_0\rangle$.

Many parameters !

Width of the energy density after a sudden quench

Initial state $|\psi_0\rangle = \sum_{\alpha} C_{\alpha} |\alpha\rangle$ ~~is an eigenstate of \hat{H}_0~~ . At $\tau = 0$

(Example, not important)

"Global
quench"

$$\hat{H}_0 \rightarrow \hat{H} = \hat{H}_0 + \hat{W} \quad \text{with} \quad \hat{W} = \sum_j \hat{w}(j) \quad \text{and} \quad \hat{H}|\alpha\rangle = E_{\alpha}|\alpha\rangle.$$

MR, V. Dunjko, and M. Olshanii, Nature **452**, 854 (2008).

Width of the energy density after a sudden quench

Initial state $|\psi_0\rangle = \sum_{\alpha} C_{\alpha} |\alpha\rangle$ ~~is an eigenstate of \hat{H}_0~~ . At $\tau = 0$

$$\hat{H}_0 \rightarrow \hat{H} = \hat{H}_0 + \hat{W} \quad \text{with} \quad \hat{W} = \sum_j \hat{w}(j) \quad \text{and} \quad \hat{H}|\alpha\rangle = E_{\alpha}|\alpha\rangle.$$

The width of the weighted energy density ΔE is then $\Delta E = \sqrt{\langle \hat{H}^2 \rangle - \langle \hat{H} \rangle^2} =$

$$\Delta E = \sqrt{\sum_{\alpha} E_{\alpha}^2 |C_{\alpha}|^2 - \left(\sum_{\alpha} E_{\alpha} |C_{\alpha}|^2\right)^2} = \sqrt{\langle \psi_0 | \hat{W}^2 | \psi_0 \rangle - \langle \psi_0 | \hat{W} | \psi_0 \rangle^2},$$

or

$$\Delta E = \sqrt{\sum_{j_1, j_2 \in \sigma} [\langle \psi_0 | \hat{w}(j_1) \hat{w}(j_2) | \psi_0 \rangle - \langle \psi_0 | \hat{w}(j_1) | \psi_0 \rangle \langle \psi_0 | \hat{w}(j_2) | \psi_0 \rangle]} \stackrel{N \rightarrow \infty}{\propto} \sqrt{N},$$

(unless terms in the sum are highly correlated!)

where N is the total number of lattice sites.

Width of the energy density after a sudden quench

Initial state $|\psi_0\rangle = \sum_{\alpha} C_{\alpha} |\alpha\rangle$ is an eigenstate of \hat{H}_0 . At $\tau = 0$

$$\hat{H}_0 \rightarrow \hat{H} = \hat{H}_0 + \hat{W} \quad \text{with} \quad \hat{W} = \sum_j \hat{w}(j) \quad \text{and} \quad \hat{H}|\alpha\rangle = E_{\alpha}|\alpha\rangle.$$

The width of the weighted energy density ΔE is then

$$\Delta E = \sqrt{\sum_{\alpha} E_{\alpha}^2 |C_{\alpha}|^2 - \left(\sum_{\alpha} E_{\alpha} |C_{\alpha}|^2\right)^2} = \sqrt{\langle \psi_0 | \hat{W}^2 | \psi_0 \rangle - \langle \psi_0 | \hat{W} | \psi_0 \rangle^2},$$

or

$$\Delta E = \sqrt{\sum_{j_1, j_2 \in \sigma} [\langle \psi_0 | \hat{w}(j_1) \hat{w}(j_2) | \psi_0 \rangle - \langle \psi_0 | \hat{w}(j_1) | \psi_0 \rangle \langle \psi_0 | \hat{w}(j_2) | \psi_0 \rangle]} \stackrel{N \rightarrow \infty}{\propto} \sqrt{N},$$

expect ?

where N is the total number of lattice sites.

Since the width W of the full energy spectrum is $\propto N$

$$\Delta \epsilon = \frac{\Delta E}{W} \stackrel{N \rightarrow \infty}{\propto} \frac{1}{\sqrt{N}},$$

so, as in any thermal ensemble, $\Delta \epsilon$ vanishes in the thermodynamic limit.

MR, V. Dunjko, and M. Olshanii, Nature **452**, 854 (2008).

- 1 Introduction
 - Experiments with ultracold gases
 - Unitary evolution and thermalization

- 2 Generic (nonintegrable) systems

Example: relaxation of hardcore bosons in 2D

- Time evolution vs exact time average
- Statistical description after relaxation
- Eigenstate thermalization hypothesis
- Time fluctuations

- 3 Integrable systems

- Time evolution
- Generalized Gibbs ensemble

- 4 Summary

Relaxation dynamics of hard-core bosons in 2D

Hard-core boson Hamiltonian (Equivalent to spin 1/2 Quantum Heisenberg model)

$$\hat{H} = -J \sum_{\langle i,j \rangle} (\hat{b}_i^\dagger \hat{b}_j + \text{H.c.}) + U \sum_{\langle i,j \rangle} \hat{n}_i \hat{n}_j, \quad \hat{b}_i^{\dagger 2} = \hat{b}_i^2 = 0$$

MR, V. Dunjko, and M. Olshanii, Nature **452**, 854 (2008).

Relaxation dynamics of hard-core bosons in 2D

Hard-core boson Hamiltonian

(Equivalent to spin 1/2 Quantum Heisenberg model)

$$\hat{H} = -J \sum_{\langle i,j \rangle} \left(\hat{b}_i^\dagger \hat{b}_j + \text{H.c.} \right) + U \sum_{\langle i,j \rangle} \hat{n}_i \hat{n}_j, \quad \hat{b}_i^{\dagger 2} = \hat{b}_i^2 = 0$$

MR, V. Dunjko, and M. Olshanii, Nature **452**, 854 (2008).

Nonequilibrium dynamics in 2D

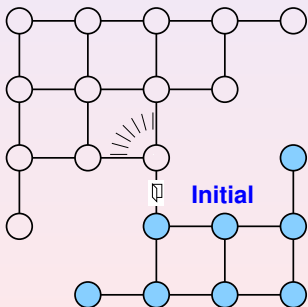

Weak n.n. $U = 0.1J$

$N_b = 5$ bosons

$N = 21$ lattice sites

Hilbert space: $D = 20349$

All states are used!

Initial state: a single occupation number state.

Time zero: become connected at one bond.

During the time evolution, ALL occupation number states occur.

Relaxation dynamics of hard-core bosons in 2D

Hard-core boson Hamiltonian

$$\hat{H} = -J \sum_{\langle i,j \rangle} \left(\hat{b}_i^\dagger \hat{b}_j + \text{H.c.} \right) + U \sum_{\langle i,j \rangle} \hat{n}_i \hat{n}_j, \quad \hat{b}_i^{\dagger 2} = \hat{b}_i^2 = 0$$

MR, V. Dunjko, and M. Olshanii, Nature **452**, 854 (2008).

“One can rewrite

(quote from page 8)

$$O(\tau) = \sum_{\alpha', \alpha} C_{\alpha'}^* C_{\alpha} e^{i(E_{\alpha'} - E_{\alpha})\tau} O_{\alpha' \alpha} \quad \text{where} \quad |\psi_0\rangle = \sum_{\alpha} C_{\alpha} |\alpha\rangle,$$

and taking the infinite time average (diagonal ensemble)

$$\overline{O(\tau)} = \lim_{\tau \rightarrow \infty} \frac{1}{\tau} \int_0^{\tau} d\tau' \langle \Psi(\tau') | \hat{O} | \Psi(\tau') \rangle = \sum_{\alpha} |C_{\alpha}|^2 O_{\alpha\alpha} \equiv \langle \hat{O} \rangle_{\text{diag}},$$

which depends on the initial conditions through $C_{\alpha} = \langle \alpha | \psi_0 \rangle$.”

Relaxation dynamics of hard-core bosons in 2D

Hard-core boson Hamiltonian

$$\hat{H} = -J \sum_{\langle i,j \rangle} \left(\hat{b}_i^\dagger \hat{b}_j + \text{H.c.} \right) + U \sum_{\langle i,j \rangle} \hat{n}_i \hat{n}_j, \quad \hat{b}_i^{\dagger 2} = \hat{b}_i^2 = 0$$

MR, V. Dunjko, and M. Olshanii, Nature **452**, 854 (2008).

Nonequilibrium dynamics in 2D

$n_k = \langle \hat{b}_k^\dagger \hat{b}_k \rangle$

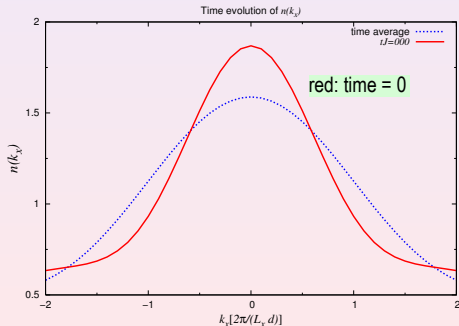

Weak n.n. $U = 0.1J$

$N_b = 5$ bosons

$N = 21$ lattice sites

Hilbert space: $D = 20349$

All states are used!

Distribution of momenta in time average
is very different from initial state

Relaxation dynamics of hard-core bosons in 2D

Hard-core boson Hamiltonian

$$\hat{H} = -J \sum_{\langle i,j \rangle} \left(\hat{b}_i^\dagger \hat{b}_j + \text{H.c.} \right) + U \sum_{\langle i,j \rangle} \hat{n}_i \hat{n}_j, \quad \hat{b}_i^{\dagger 2} = \hat{b}_i^2 = 0$$

MR, V. Dunjko, and M. Olshanii, Nature **452**, 854 (2008).

Nonequilibrium dynamics in 2D

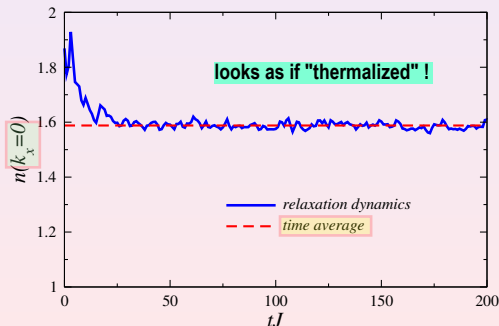

Weak n.n. $U = 0.1J$

$N_b = 5$ bosons

$N = 21$ lattice sites

Hilbert space: $D = 20349$

All states are used!

- 1 Introduction
 - Experiments with ultracold gases
 - Unitary evolution and thermalization

- 2 Generic (nonintegrable) systems
 - Time evolution vs exact time average
 - **Statistical description after relaxation**
 - Eigenstate thermalization hypothesis
 - Time fluctuations

- 3 Integrable systems
 - Time evolution
 - Generalized Gibbs ensemble

- 4 Summary

Not good: Canonical calculation

$$O = \text{Tr} \left\{ \hat{O} \hat{\rho} \right\}$$

$$\hat{\rho} = Z^{-1} \exp \left(-\hat{H} / k_B T \right)$$

$$Z = \text{Tr} \left\{ \exp \left(-\hat{H} / k_B T \right) \right\}$$

$$E_{\text{avg}} = \text{Tr} \left\{ \hat{H} \hat{\rho} \right\} \quad T = 1.9J$$

(T: best match)

Momentum distribution

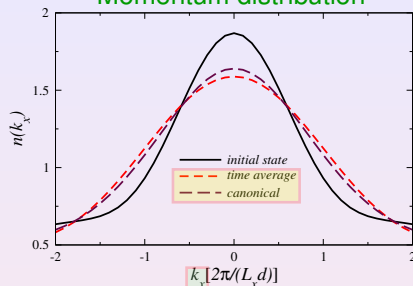

Statistical description after relaxation

Canonical calculation

$$O = \text{Tr} \{ \hat{O} \hat{\rho} \}$$

$$\hat{\rho} = Z^{-1} \exp \left(-\hat{H} / k_B T \right)$$

$$Z = \text{Tr} \left\{ \exp \left(-\hat{H} / k_B T \right) \right\}$$

$$E_{\hat{O}} = \text{Tr} \left\{ \hat{H} \hat{\rho} \right\} \quad T = 1.9J$$

Momentum distribution

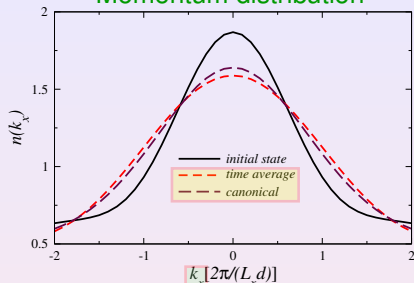

Very good:

Microcanonical calculation with energy of initial state

$$O = \frac{1}{N_{states}} \sum_{\alpha} \langle \Psi_{\alpha} | \hat{O} | \Psi_{\alpha} \rangle$$

= eigenstates

with $E_0 - \Delta E < E_{\alpha} < E_0 + \Delta E$

N_{states} : # of states in the window

E_0 : energy of initial state !

ΔE : a small energy width (here approx. 2% of E_0)

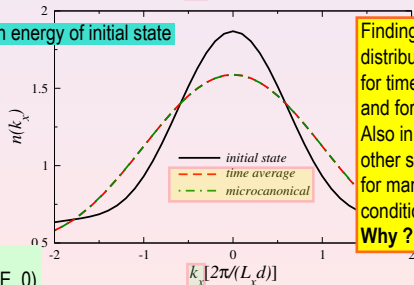

Finding same distribution for time average and for "microcan." Also in many other systems, for many initial conditions. **Why ?**

- 1 Introduction
 - Experiments with ultracold gases
 - Unitary evolution and thermalization

- 2 Generic (nonintegrable) systems
 - Time evolution vs exact time average
 - Statistical description after relaxation
 - **Eigenstate thermalization hypothesis**
 - Time fluctuations

- 3 Integrable systems
 - Time evolution
 - Generalized Gibbs ensemble

- 4 Summary

Paradox?

$$\text{Time average} = \sum_{\alpha} |C_{\alpha}|^2 O_{\alpha\alpha} \stackrel{!?}{=} \langle O \rangle_{\text{microcan.}}(E_0) \equiv \frac{1}{N_{E_0, \Delta E}} \sum_{|E_0 - E_{\alpha}| < \Delta E} O_{\alpha\alpha} \quad (1)$$

Left hand side: Depends on the initial conditions through $C_{\alpha} = \langle \Psi_{\alpha} | \psi_I \rangle$

Right hand side: Depends only on the initial energy

Eigenstate thermalization hypothesis

Paradox?

$$\text{Time average} = \sum_{\alpha} |C_{\alpha}|^2 O_{\alpha\alpha} = \langle O \rangle_{\text{microcan.}}(E_0) \equiv \frac{1}{N_{E_0, \Delta E}} \sum_{|E_0 - E_{\alpha}| < \Delta E} O_{\alpha\alpha}$$

Left hand side: Depends on the initial conditions through $C_{\alpha} = \langle \Psi_{\alpha} | \psi_I \rangle$

Right hand side: Depends only on the initial energy

Potential explanations: 0) Usually required: C_{α} significant only in a small energy window around E_0 (cases in which (1) holds) (or suitable cancellations, see e.g. page 16)

i) For physically relevant initial conditions, $|C_{\alpha}|^2$ ~~practically do not fluctuate~~ (in alpha, within the energy window) (not typically true, see next page)

ii) Large (and uncorrelated) ^(with $O_{\alpha\alpha}$) fluctuations occur in ~~both $O_{\alpha\alpha}$ and $|C_{\alpha}|^2$~~ . A physically relevant initial state performs an unbiased sampling of $O_{\alpha\alpha}$. ^{Then the} i.e., then the equality (1) is true. ?

MR and M. Srednicki, PRL **108**, 110601 (2012).

or iii) The matrix elements $O_{\alpha\alpha}$ of the observable are almost **constant** in the relevant energy range, and cancel for other energies.

Then equality (1) is true AND also equal to exp. value $\langle O \rangle$ in a SINGLE eigenstate within the energy window !!

Eigenstate thermalization hypothesis

Paradox?

$$\sum_{\alpha} |C_{\alpha}|^2 O_{\alpha\alpha} = \langle O \rangle_{\text{microcan.}}(E_0) \equiv \frac{1}{N_{E_0, \Delta E}} \sum_{E_0 - E_{\alpha} < \Delta E} O_{\alpha\alpha}$$

Left hand side: Depends on the initial conditions through $C_{\alpha} = \langle \Psi_{\alpha} | \psi_I \rangle$

Right hand side: Depends only on the initial energy

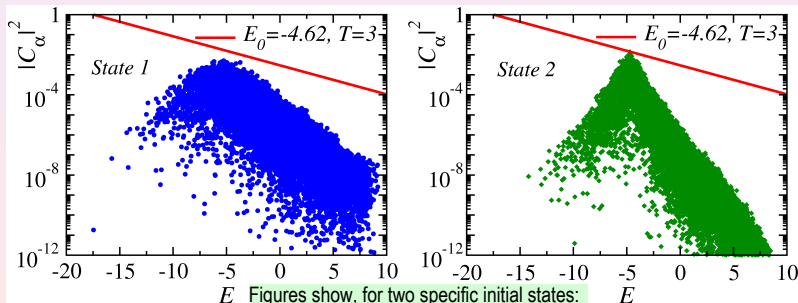

MR, PRA **82**, 037601 (2010).

Eigenstate thermalization hypothesis

Paradox?

(this is the same as first part of p.15)

$$\sum_{\alpha} |C_{\alpha}|^2 O_{\alpha\alpha} = \langle O \rangle_{\text{microcan.}}(E_0) \equiv \frac{1}{N_{E_0, \Delta E}} \sum_{|E_0 - E_{\alpha}| < \Delta E} O_{\alpha\alpha}$$

Left hand side: Depends on the initial conditions through $C_{\alpha} = \langle \Psi_{\alpha} | \psi_I \rangle$

Right hand side: Depends only on the initial energy

Potential explanations:

- i) For physically relevant initial conditions, $|C_{\alpha}|^2$ practically do not fluctuate.
- ii) Large (and uncorrelated) fluctuations occur in both $O_{\alpha\alpha}$ and $|C_{\alpha}|^2$. A physically relevant initial state performs an unbiased sampling of $O_{\alpha\alpha}$.

(see first part of p.15 for commented version)

MR and M. Srednicki, PRL **108**, 110601 (2012).

Eigenstate thermalization hypothesis

Paradox?

$$\sum_{\alpha} |C_{\alpha}|^2 O_{\alpha\alpha} = \langle O \rangle_{\text{microcan.}}(E_0) \equiv \frac{1}{N_{E_0, \Delta E}} \sum_{E_0 - E_{\alpha} < \Delta E} O_{\alpha\alpha}$$

Left hand side: Depends on the initial conditions through $C_{\alpha} = \langle \Psi_{\alpha} | \psi_I \rangle$

Right hand side: Depends only on the initial energy

Eigenstate thermalization hypothesis (ETH)

[J. M. Deutsch, PRA **43** 2046 (1991); M. Srednicki, PRE **50**, 888 (1994);

MR, V. Dunjko, and M. Olshanii, Nature **452**, 854 (2008).]

few body observable in large system

=> averaging over many particles (similar to averaging in a bath)

- iii) The expectation value $\langle \Psi_{\alpha} | \hat{O} | \Psi_{\alpha} \rangle$ of a few-body observable \hat{O} in an eigenstate of the Hamiltonian $|\Psi_{\alpha}\rangle$, with energy E_{α} , of a large interacting many-body system equals the thermal average of \hat{O} at the mean energy E_{α} : (microcanonical (with energy window of $\pm 2\%$))

$$O_{aa} = \langle \Psi_{\alpha} | \hat{O} | \Psi_{\alpha} \rangle = \langle O \rangle_{\text{microcan.}}(E_{\alpha})$$

This ETH is sometimes true (approximately), but not always

i.e. O_{aa} (almost) constant in small neighborhood of E_{α}

Eigenstate thermalization hypothesis

Momentum distribution

Eigenstates $a - d$ are the ones with energies closest to E_0

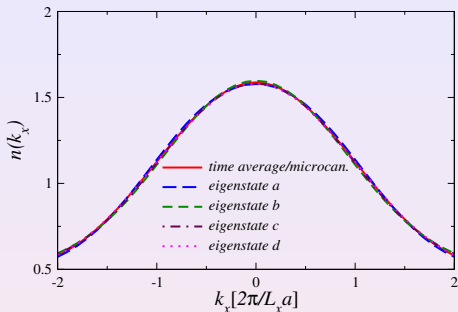

Eigenstate thermalization hypothesis

Momentum distribution

Eigenstates $a - d$ are the ones with energies closest to E_0

Figures show: the momentum distributions of (1) time average, (2) microcan., and (3) several eigenstates are very similar (Fig.1) even though their energy distributions are VERY different (Fig.2)

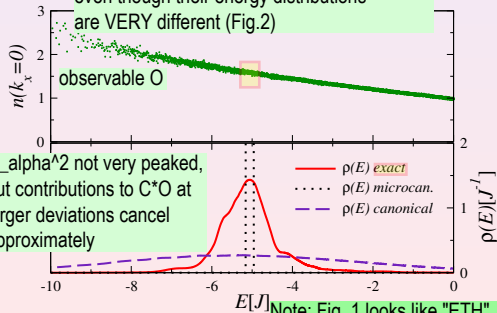
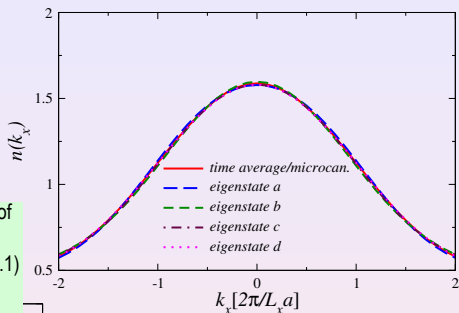

$n(k_x = 0)$ vs energy

$$\rho(E) = P(E) \times \text{dens. stat.}$$

$$P(E)_{\text{exact}} \rightarrow |C_\alpha|^2 \quad (\text{"exact" refers to initial state and time average})$$

$$P(E)_{\text{mic}} \rightarrow \text{constant}$$

$$P(E)_{\text{can}} \rightarrow \exp(-E/k_B T)$$

(but (i) and (ii) are satisfied)

Note: Fig. 1 looks like "ETH", but none of the explanations (i),(ii),(iii) actually satisfied

One-dimensional **integrable** case

Next:
integrable case

Similar experiment in one dimension

Initial

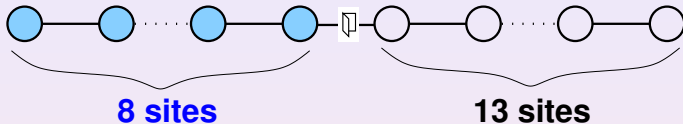

One-dimensional **integrable** case

Similar experiment in one dimension

Initial

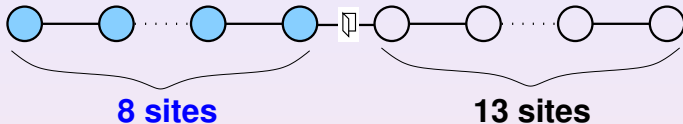

Time average vs Stat. Mech.

No thermalization!

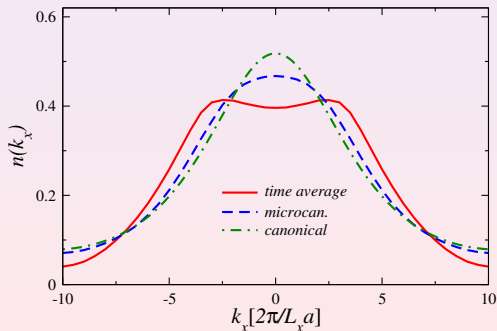

Breakdown of eigenstate thermalization

Momentum distribution

Eigenstates $a - d$ are the ones with energies closest to E_0

Very different from page 16

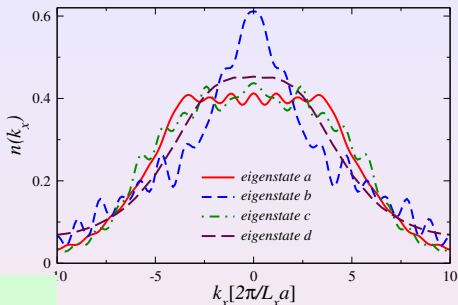

Observable O_{aa} is NOT approx. constant for different eigenstates around E_0

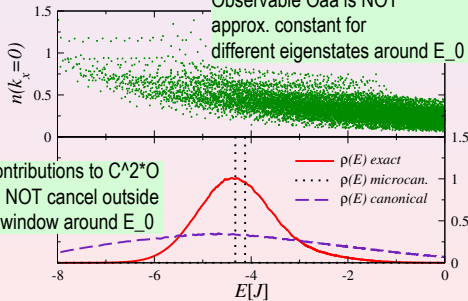

Contributions to $C^2 \langle O \rangle$ do NOT cancel outside of window around E_0

$n(k_x = 0)$ vs energy

$\rho(E) = P(E) \times \text{dens. stat.}$

$P(E)_{\text{exact}} \rightarrow |C_\alpha|^2$ ("exact" refers to time average)

$P(E)_{\text{mic}} \rightarrow \text{constant}$

$P(E)_{\text{can}} \rightarrow \exp(-E/k_B T)$

Integrable vs Nonintegrable cases

Correlations between $n(k)$ and C_α

1D (integrable) case

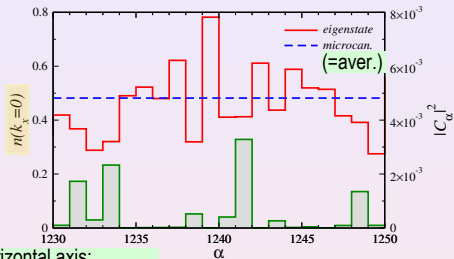

horizontal axis:
successive eigenstates
(Green bars: C_α)



Conservation laws play a role in integrable models.

==> need to use distribution with all conserved parameters: GGA "Generalized Gibbs Ensemble", see p.30
Transition between integrability and nonintegrability:

MR, PRL **103**, 100403 (2009); PRA **80**, 053607 (2009).

2D (nonintegrable) case

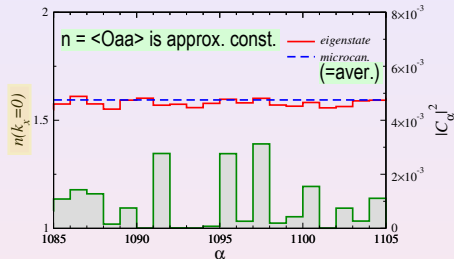

Correlations are not relevant, and they are not present!

- 1 Introduction
 - Experiments with ultracold gases
 - Unitary evolution and thermalization

- 2 Generic (nonintegrable) systems
 - Time evolution vs exact time average
 - Statistical description after relaxation
 - Eigenstate thermalization hypothesis
 - **Time fluctuations**

- 3 Integrable systems
 - Time evolution
 - Generalized Gibbs ensemble

- 4 Summary

Relaxation dynamics of hard-core bosons in 2D

(not an integrable model)

Hard-core boson Hamiltonian

$$\hat{H} = -J \sum_{\langle i,j \rangle} (\hat{b}_i^\dagger \hat{b}_j + \text{H.c.}) + U \sum_{\langle i,j \rangle} \hat{n}_i \hat{n}_j, \quad \hat{b}_i^{\dagger 2} = \hat{b}_i^2 = 0$$

(Same slide as last part of "page 11")

(Equivalent to spin 1/2 Quantum Heisenberg model)

Nonequilibrium dynamics in 2D

Weak n.n. $U = 0.1J$

$N_b = 5$ bosons

$N = 21$ lattice sites

Hilbert space: $D = 20349$

All states are used!

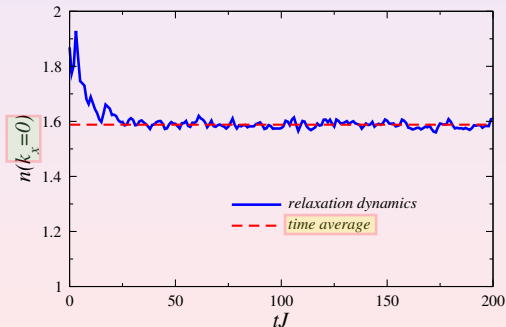

Time fluctuations

Are they small because of dephasing?

$$\underbrace{\langle \hat{O}(t) \rangle - \overline{\langle \hat{O}(t) \rangle}}_{\text{time average}} = \sum_{\substack{\alpha', \alpha \\ \alpha' \neq \alpha}} C_{\alpha'}^* C_{\alpha} e^{i(E_{\alpha'} - E_{\alpha})t} O_{\alpha' \alpha} \stackrel{?}{\sim} \sum_{\substack{\alpha', \alpha \\ \alpha' \neq \alpha}} \frac{e^{i(E_{\alpha'} - E_{\alpha})t}}{N_{\text{states}}} O_{\alpha' \alpha}$$
$$\stackrel{?}{\sim} \frac{\sqrt{N_{\text{states}}^2}}{N_{\text{states}}} O_{\alpha' \alpha}^{\text{typical}} \sim O_{\alpha' \alpha}^{\text{typical}}$$

sqrt(N^2) results when the exponential is randomly distributed (why should it be?)

Then all phases cancel,
i.e. only alpha=alpha' contributes

Time fluctuations

Are they small because of dephasing?

$$\langle \hat{O}(t) \rangle - \overline{\langle \hat{O}(t) \rangle} = \sum_{\substack{\alpha', \alpha \\ \alpha' \neq \alpha}} C_{\alpha'}^* C_{\alpha} e^{i(E_{\alpha'} - E_{\alpha})t} O_{\alpha' \alpha} \stackrel{?}{\sim} \sum_{\substack{\alpha', \alpha \\ \alpha' \neq \alpha}} \frac{e^{i(E_{\alpha'} - E_{\alpha})t}}{N_{\text{states}}} O_{\alpha' \alpha}$$
$$\sim \frac{\sqrt{N_{\text{states}}^2}}{N_{\text{states}}} O_{\alpha' \alpha}^{\text{typical}} \sim O_{\alpha' \alpha}^{\text{typical}}$$

sqrt(N^2) results when the exponential is randomly distributed (why should it be?)
Then all phases cancel,
i.e. only alpha=alpha' contributes

Time average of $\langle \hat{O} \rangle$

$$\overline{\langle \hat{O} \rangle} = \sum_{\alpha} |C_{\alpha}|^2 O_{\alpha \alpha}$$
$$\sim \sum_{\alpha} \frac{1}{N_{\text{states}}} O_{\alpha \alpha} \sim O_{\alpha \alpha}^{\text{typical}}$$

Time fluctuations

Are they small because of dephasing?

$$\langle \hat{O}(t) \rangle - \overline{\langle \hat{O}(t) \rangle} = \sum_{\substack{\alpha', \alpha \\ \alpha' \neq \alpha}} C_{\alpha'}^* C_{\alpha} e^{i(E_{\alpha'} - E_{\alpha})t} O_{\alpha' \alpha} \sim \sum_{\substack{\alpha', \alpha \\ \alpha' \neq \alpha}} \frac{e^{i(E_{\alpha'} - E_{\alpha})t}}{N_{\text{states}}} O_{\alpha' \alpha}$$

NOT the time average!
(see page 8)

from subtraction

(when C_{α} is sharply peaked)

$$\sim \frac{\sqrt{N_{\text{states}}^2}}{N_{\text{states}}} O_{\alpha' \alpha}^{\text{typical}} \sim O_{\alpha' \alpha}^{\text{typical}}$$

Time average of $\langle \hat{O} \rangle$

$$\overline{\langle \hat{O} \rangle} = \sum_{\alpha} |C_{\alpha}|^2 O_{\alpha \alpha}$$

(when ETH is valid):

$$\sim \sum_{\alpha} \frac{1}{N_{\text{states}}} O_{\alpha \alpha} \sim O_{\alpha \alpha}^{\text{typical}}$$

Figure shows that indeed only $\alpha = \alpha'$ contributes to the expectation value

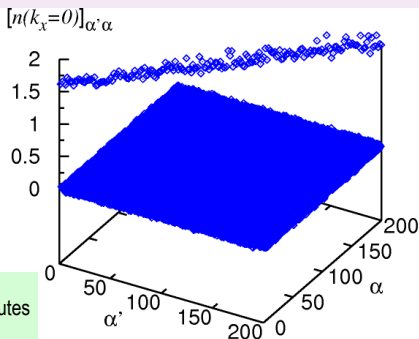

Fluctuation-dissipation theorem (dipolar bosons)

Occupation in the center of the trap ($n_{j=L/2}$)

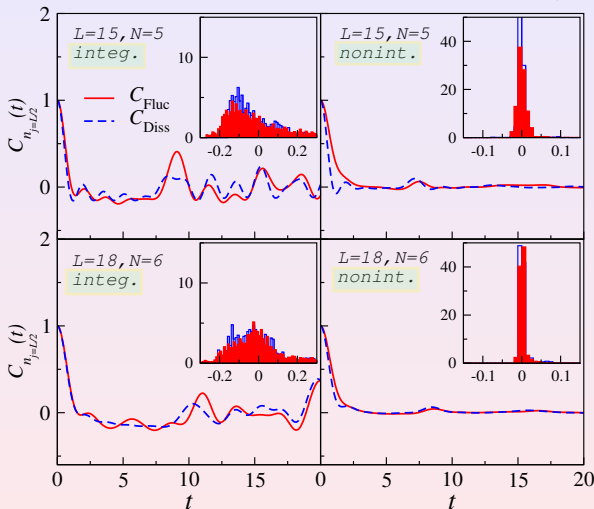

Hamiltonian

$$\hat{H} = -J \sum_{j=1}^{L-1} \left(\hat{b}_j^\dagger \hat{b}_{j+1} + \text{H.c.} \right) + V \sum_{j < l} \frac{\hat{n}_j \hat{n}_l}{|j-l|^3} + g \sum_j \underbrace{x_j^2}_{\text{"dipolar IA"}} \hat{n}_j$$

$\underbrace{\quad}_{\text{trap}}$

magnetic atoms, polar molecules

Relaxation dynamics

$$O(t) = C(t)O(t=0)$$

where

$$C(t) = \frac{\overline{O(t+t')O(t')}}{\overline{O(t')^2}}$$

Srednicki, JPA **32**, 1163 (1999).

E. Khatami, G. Pupillo, M. Srednicki, and MR, PRL **111**, 050403 (2013).

- 1 Introduction
 - Experiments with ultracold gases
 - Unitary evolution and thermalization

- 2 Generic (nonintegrable) systems
 - Time evolution vs exact time average
 - Statistical description after relaxation
 - Eigenstate thermalization hypothesis
 - Time fluctuations

- 3 **Integrable systems**
 - **Time evolution**
 - Generalized Gibbs ensemble

- 4 Summary

Bose-Fermi mapping

Hard-core boson Hamiltonian in an external potential

$$\hat{H} = -J \sum_i \left(\hat{b}_i^\dagger \hat{b}_{i+1} + \text{H.c.} \right) + \sum_i v_i \hat{n}_i$$

Constraints on the bosonic operators

$$\hat{b}_i^{\dagger 2} = \hat{b}_i^2 = 0$$

Bose-Fermi mapping

Hard-core boson Hamiltonian in an external potential

1 dim

$$\hat{H} = -J \sum_i \left(\hat{b}_i^\dagger \hat{b}_{i+1} + \text{H.c.} \right) + \sum_i v_i \hat{n}_i$$

Here: no density-density interaction !

Constraints on the bosonic operators

$$\hat{b}_i^{\dagger 2} = \hat{b}_i^2 = 0$$

Since $n_i = b_i^\dagger b_i$, this Hamiltonian is bilinear in creation and annihilation operators and the eigenstates are products of single particle states. (Special case $v_i = \text{const}$: momentum space states)



Map to spins and then to fermions (Jordan-Wigner transformation)

$$\sigma_i^+ = \hat{f}_i^\dagger \prod_{\beta=1}^{i-1} e^{-i\pi \hat{f}_\beta^\dagger \hat{f}_\beta}, \quad \sigma_i^- = \prod_{\beta=1}^{i-1} e^{i\pi \hat{f}_\beta^\dagger \hat{f}_\beta} \hat{f}_i$$

$= (-1)^{\text{(number of fermions before site } i)}$
 \implies in 1d provides for anticommutation

Mapping results in



Non-interacting fermion Hamiltonian

Signs cancel as long as fermions cannot hop past each other !

$$\hat{H}_F = -J \sum_i \left(\hat{f}_i^\dagger \hat{f}_{i+1} + \text{H.c.} \right) + \sum_i v_i \hat{n}_i^f$$

(This is an integrable model)

One-particle density matrix

One-particle Green's function

$$G_{ij} = \langle \Psi_{HCB} | \sigma_i^- \sigma_j^+ | \Psi_{HCB} \rangle = \langle \Psi_F | \prod_{\beta=1}^{i-1} e^{i\pi \hat{f}_\beta^\dagger \hat{f}_\beta} \hat{f}_i \hat{f}_j^\dagger \prod_{\gamma=1}^{j-1} e^{-i\pi \hat{f}_\gamma^\dagger \hat{f}_\gamma} | \Psi_F \rangle$$



For non-neighboring sites i, j
each interchange of fermions
gives a sign \rightarrow need to cancel
by e-factors

Time evolution

$$|\Psi_F(\tau)\rangle = e^{-i\hat{H}_F\tau/\hbar} |\Psi_F^I\rangle = \prod_{\delta=1}^N \sum_{\sigma=1}^L P_{\sigma\delta}(\tau) \hat{f}_\sigma^\dagger |0\rangle$$

One-particle density matrix

One-particle Green's function

$$G_{ij} = \langle \Psi_{HCB} | \sigma_i^- \sigma_j^+ | \Psi_{HCB} \rangle = \langle \Psi_F | \prod_{\beta=1}^{i-1} e^{i\pi \hat{f}_\beta^\dagger \hat{f}_\beta} \hat{f}_i \hat{f}_j^\dagger \prod_{\gamma=1}^{j-1} e^{-i\pi \hat{f}_\gamma^\dagger \hat{f}_\gamma} | \Psi_F \rangle$$



For non-neighboring sites i, j each interchange of fermions gives a sign \rightarrow cancelled by e-factors

Time evolution from an initial Fock state

remains a Fock state, which can be written as:

$$|\Psi_F(\tau)\rangle = e^{-i\hat{H}_F\tau/\hbar} |\Psi_F^I\rangle = \prod_{\delta=1}^N \sum_{\sigma=1}^L P_{\sigma\delta}(\tau) \hat{f}_\sigma^\dagger |0\rangle$$



Fock state: $\prod_k (c^\dagger_k)^{n_k} |0\rangle$
 $= \prod_k \sum_x e^{i(k \cdot x - n_k)} c^\dagger_x |0\rangle$
 $= \prod_n (\sum_x e^{i(k \cdot n - x)} c^\dagger_x |0\rangle)$
 $= \prod_n \sum_x P_{(k \cdot n - x)} c^\dagger_x |0\rangle$

Exact Green's function

$$G_{ij}(\tau) = \det \left[(\mathbf{P}^l(\tau))^\dagger \mathbf{P}^r(\tau) \right]$$

Here "k" numbers the single particle eigenstates (= momentum states when $v_i = \text{const}$ in Hamiltonian)

Computation time $\sim L^2 N^3$

3000 lattice sites, 300 particles

MR and A. Muramatsu, PRL **93**, 230404 (2004); PRL **94**, 240403 (2005).

Relaxation dynamics in an integrable system

Initial state:
center part of system filled at approx. constant density

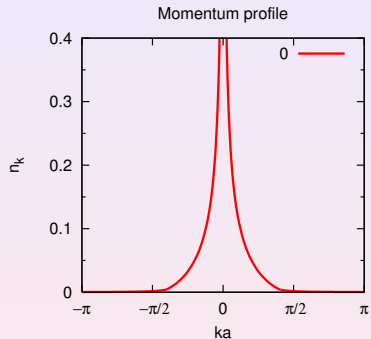
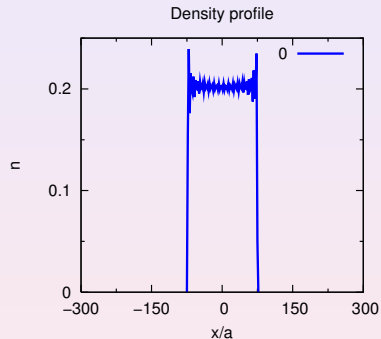

MR, V. Dunjko, V. Yurovsky, and M. Olshanii, PRL **98**, 050405 (2007).

Relaxation dynamics in an integrable system

State after long time relaxation:
combination of (a few) eigenstates

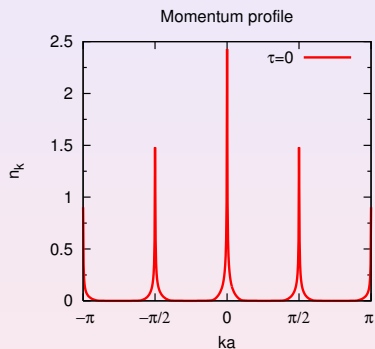
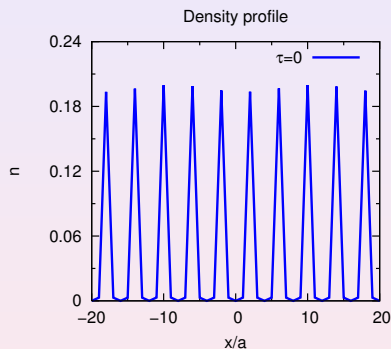

MR, V. Dunjko, V. Yurovsky, and M. Olshanii, PRL **98**, 050405 (2007).

- 1 Introduction
 - Experiments with ultracold gases
 - Unitary evolution and thermalization

- 2 Generic (nonintegrable) systems
 - Time evolution vs exact time average
 - Statistical description after relaxation
 - Eigenstate thermalization hypothesis
 - Time fluctuations

- 3 Integrable systems
 - Time evolution
 - **Generalized Gibbs ensemble**

- 4 Summary

Thermal equilibrium

$$\hat{\rho} = Z^{-1} \exp \left[- \left(\hat{H} - \mu \hat{N}_b \right) / k_B T \right]$$

$$Z = \text{Tr} \left\{ \exp \left[- \left(\hat{H} - \mu \hat{N}_b \right) / k_B T \right] \right\}$$

$$E = \text{Tr} \left\{ \hat{H} \hat{\rho} \right\}, \quad N_b = \text{Tr} \left\{ \hat{N}_b \hat{\rho} \right\}$$

MR, PRA **72**, 063607 (2005).

Statistical description after relaxation

Thermal equilibrium

$$\hat{\rho} = Z^{-1} \exp \left[- \left(\hat{H} - \mu \hat{N}_b \right) / k_B T \right]$$

$$Z = \text{Tr} \left\{ \exp \left[- \left(\hat{H} - \mu \hat{N}_b \right) / k_B T \right] \right\}$$

$$E = \text{Tr} \left\{ \hat{H} \hat{\rho} \right\}, \quad N_b = \text{Tr} \left\{ \hat{N}_b \hat{\rho} \right\}$$

MR, PRA **72**, 063607 (2005).

Evolution of $n_{k=0}$

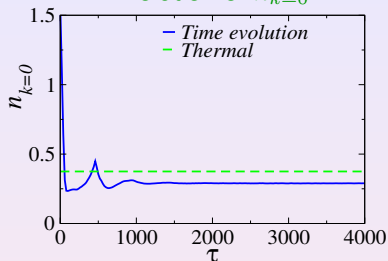

n_k after relaxation

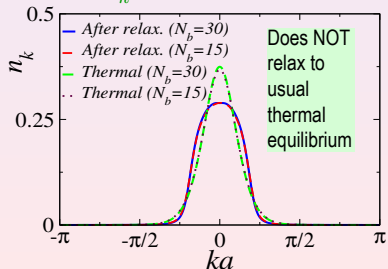

Thermal equilibrium

$$\hat{\rho} = Z^{-1} \exp \left[- \left(\hat{H} - \mu \hat{N}_b \right) / k_B T \right]$$

$$Z = \text{Tr} \left\{ \exp \left[- \left(\hat{H} - \mu \hat{N}_b \right) / k_B T \right] \right\}$$

$$E = \text{Tr} \left\{ \hat{H} \hat{\rho} \right\}, \quad N_b = \text{Tr} \left\{ \hat{N}_b \hat{\rho} \right\}$$

MR, PRA **72**, 063607 (2005).

Integrals of motion

(underlying noninteracting fermions)

$$\hat{H}_F \hat{\gamma}_m^{f\dagger} |0\rangle = E_m \hat{\gamma}_m^{f\dagger} |0\rangle$$

$$\left\{ \hat{I}_m^f \right\} = \left\{ \hat{\gamma}_m^{f\dagger} \hat{\gamma}_m^f \right\}$$

Many local conserved quantities I_m^f

Evolution of $n_{k=0}$

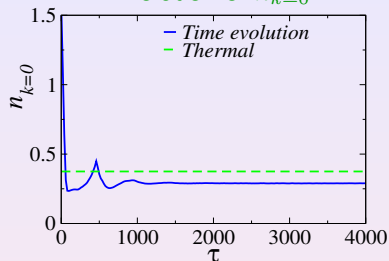

n_k after relaxation

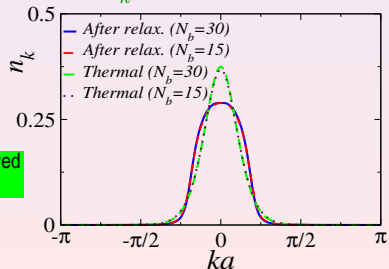

Statistical description after relaxation

Thermal equilibrium

$$\hat{\rho} = Z^{-1} \exp \left[- \left(\hat{H} - \mu \hat{N}_b \right) / k_B T \right]$$
$$Z = \text{Tr} \left\{ \exp \left[- \left(\hat{H} - \mu \hat{N}_b \right) / k_B T \right] \right\}$$
$$E = \text{Tr} \left\{ \hat{H} \hat{\rho} \right\}, \quad N_b = \text{Tr} \left\{ \hat{N}_b \hat{\rho} \right\}$$

MR, PRA **72**, 063607 (2005).

Generalized Gibbs ensemble

$$\hat{\rho}_c = Z_c^{-1} \exp \left[- \sum_m \lambda_m \hat{I}_m \right] \quad \text{instead of } e^{\Lambda(-H/T)}$$
$$Z_c = \text{Tr} \left\{ \exp \left[- \sum_m \lambda_m \hat{I}_m \right] \right\}$$
$$\langle \hat{I}_m \rangle_{\tau=0} = \text{Tr} \left\{ \hat{I}_m \hat{\rho}_c \right\}$$

Values of local quantities I_m in the initial state fix the parameters λ_m

Evolution of $n_{k=0}$

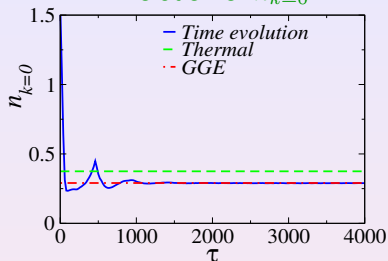

n_k after relaxation

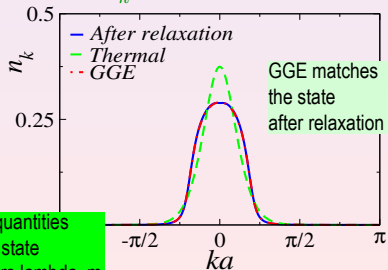

Statistical description after relaxation

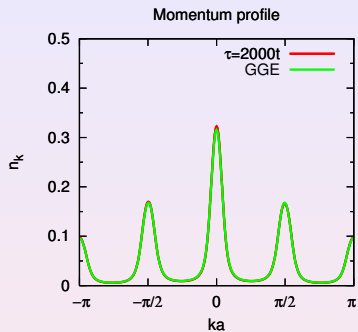
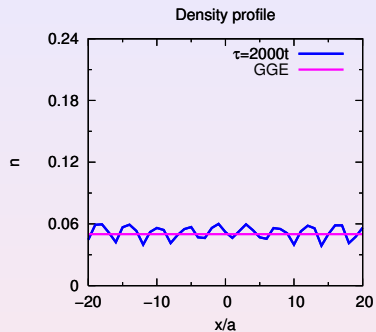

Statistical description after relaxation

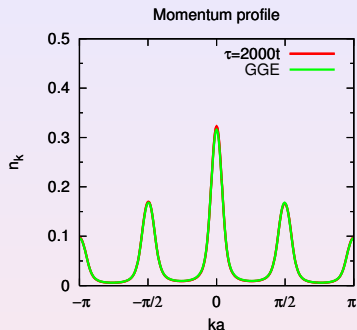
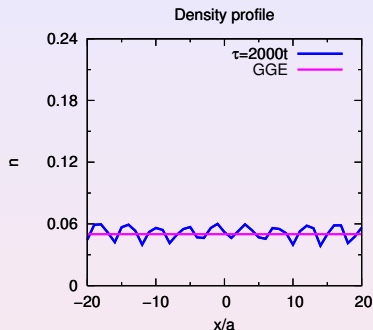

Why does the GGE work?

Generalized eigenstate thermalization:

A. C. Cassidy, C. W. Clark, and MR, Phys. Rev. Lett. **106**, 140405 (2011).

K. He, L. F. Santos, T. M. Wright, and MR, Phys. Rev. A **87**, 063637 (2013).

J.-S. Caux and F. H. L. Essler, Phys. Rev. Lett. **110**, 257203 (2013).

Summary

- Thermalization occurs in generic isolated systems
 - ★ Finite size effects

Summary

- Thermalization occurs in generic isolated systems
 - ★ Finite size effects
- Eigenstate thermalization hypothesis
 - ★ $\langle \Psi_\alpha | \hat{O} | \Psi_\alpha \rangle = \langle O \rangle_{\text{microcan.}}(E_\alpha)$

Summary

- Thermalization occurs in generic isolated systems
 - ★ Finite size effects
- Eigenstate thermalization hypothesis
 - ★ $\langle \Psi_\alpha | \hat{O} | \Psi_\alpha \rangle = \langle O \rangle_{\text{microcan.}}(E_\alpha)$
- Thermalization and ETH break down close integrability (finite system)
 - ★ Quantum equivalent of KAM?

Summary

- Thermalization occurs in generic isolated systems
 - ★ Finite size effects
- Eigenstate thermalization hypothesis
 - ★ $\langle \Psi_\alpha | \hat{O} | \Psi_\alpha \rangle = \langle O \rangle_{\text{microcan.}}(E_\alpha)$
- Thermalization and ETH break down close integrability (finite system)
 - ★ Quantum equivalent of KAM?
- Small time fluctuations ← smallness of off-diagonal elements

Summary

- Thermalization occurs in generic isolated systems
 - ★ Finite size effects
- Eigenstate thermalization hypothesis
 - ★ $\langle \Psi_\alpha | \hat{O} | \Psi_\alpha \rangle = \langle O \rangle_{\text{microcan.}}(E_\alpha)$
- Thermalization and ETH break down close integrability (finite system)
 - ★ Quantum equivalent of KAM?
- Small time fluctuations \leftarrow smallness of off-diagonal elements
- Time plays only an auxiliary role

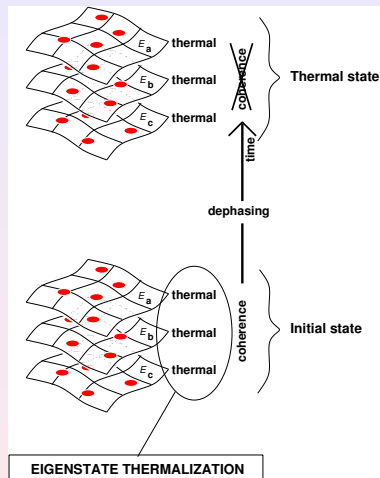

Summary

- Thermalization occurs in generic isolated systems
 - ★ Finite size effects
- Eigenstate thermalization hypothesis
 - ★ $\langle \Psi_\alpha | \hat{O} | \Psi_\alpha \rangle = \langle O \rangle_{\text{microcan.}}(E_\alpha)$
- Thermalization and ETH break down close integrability (finite system)
 - ★ Quantum equivalent of KAM?
- Small time fluctuations \leftarrow smallness of off-diagonal elements
- Time plays only an auxiliary role
- Integrable systems are different (Generalized Gibbs ensemble)

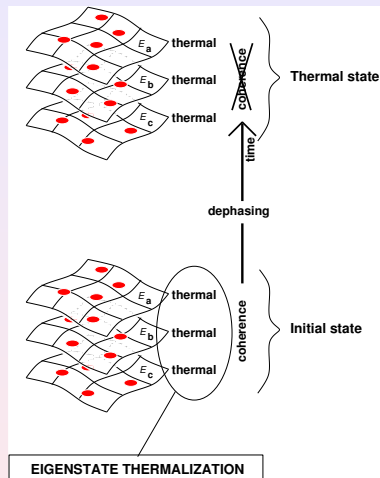

Collaborators

- Vanja Dunjko (U Mass Boston)
- Alejandro Muramatsu (Stuttgart U)
- Maxim Olshanii (U Mass Boston)
- Lea F. Santos (Yeshiva U)
- Mark Srednicki (UC Santa Barbara)
- **Former group members:** Kai He, Ehsan Khatami

Supported by:



Information entropy ($S_j = -\sum_{k=1}^D |c_j^k|^2 \ln |c_j^k|^2$)

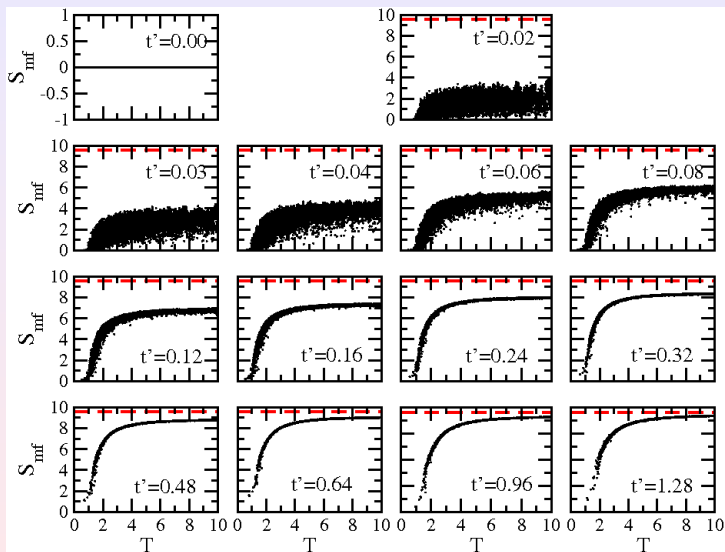

L.F. Santos and MR, PRE **81**, 036206 (2010); PRE **82**, 031130 (2010).